

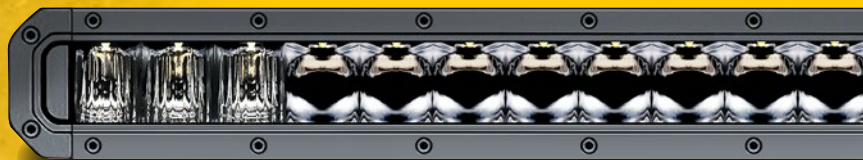

Technology with Vision

HELLA NEW ZEALAND
BLACK MAGIC DRIVING LIGHTS

ADVENTURE
STARTS HERE



TAKE US ON YOUR NEXT ADVENTURE

BLACK MAGIC DRIVING LIGHTS

Introducing the HELLA Black Magic Light Bar range — the ultimate lighting solution designed to tackle any challenge.

Striking all-black designs look stunning from every angle, though the allure doesn't stop at aesthetics. Powerful illumination, in long-distance Spot or all-in-one Combi beam options, leaves no area in darkness.

Start your Adventures with the confidence of optimal performance in all conditions, and end with the reassurance of a 2 year manufacturer's warranty.

Impact & Shock
Resistant Lens



Integrated Thermal Management



Powerful Illumination

Rugged All-Black Design

Completely Sealed
Against Dust and Water

Versatile Mounting,
Upright or Pendant

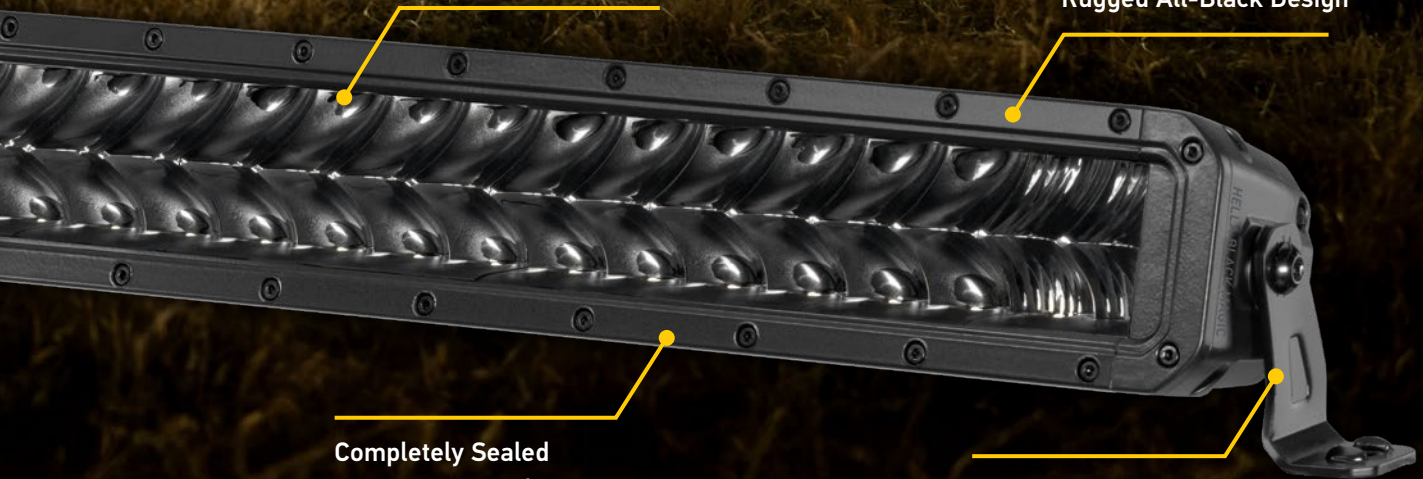

BLACK MAGIC TOUGH



Crafted for durability, Black Magic Light Bars boast IP68 / IP69K dust and water resistance, making them perfect for the rugged conditions of New Zealand, no matter where your adventures take you.

Choose from 4 different size and power variants up to 13500 lumen to find the perfect fit for your off-road needs. Illuminate your path with HELLA Black Magic TOUGH Light Bars and explore the night like never before.

20" Single Row Light Bar

1GJ 358 197-301 (Pencil)



40" Single Row Light Bar

1GJ 358 197-321 (Pencil)



21.5" Double Row Light Bar

1GJ 358 197-401 (Combi)



30" Double Row Light Bar

1GJ 358 197-411 (Combi)



Model	20" Single Row Light Bar	40" Single Row Light Bar	21.5" Double Row Light Bar	30" Double Row Light Bar
Part Number	1GJ 358 197-301	1GJ 358 197-321	1GJ 358 197-401	1GJ 358 197-411
Beam	Pencil	Pencil	Combi	Combi
Max Light Output (lumen)	6000	12000	11000	13500
Beam Distance (Metres)	600m @ 1Lux	870m @ 1Lux	735m @ 1Lux	845m @ 1Lux
Beam Width (Metres)	44m @ 1Lux	56m @ 1Lux	50m @ 1Lux	70m @ 1Lux
Max Power Consumption	107W	239W	215W	310W
Weight	2450g	4000g	3200g	4500g
ECE R10	Recommended for Motorsport or off-road use only. Must be switched independently of headlamps.			
Mounting	Upright/pendant			
Voltage	10-30V DC (suitable for 12 or 24V DC applications)			
Colour temperature	5700K			
Cable length	2m cable with open ends			
Protection	Reverse polarity protection. IP68 (Protection against dust and water immersion). IP69K (Protection against dust and high-pressure/steam jet cleaning)			
Housing	Aluminium, black stainless steel bracket			
Compliance	CE			

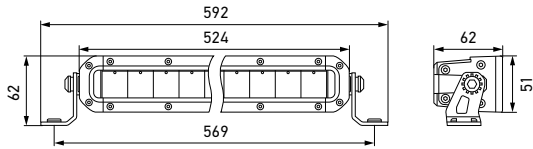

1GJ 358 197-301 20" Single Row Light Bar

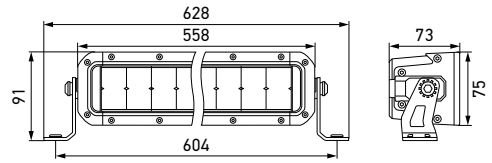

1GJ 358 197-401 21.5" Double Row Light Bar

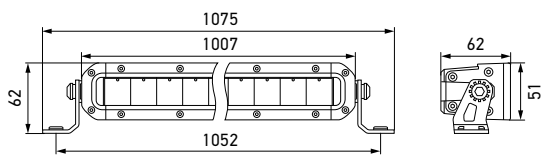

1GJ 358 197-321 40" Single Row Light Bar

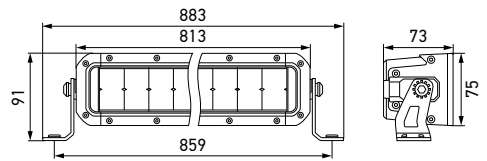

1GJ 358 197-411 30" Double Row Light Bar

All dimensions in mm

1GJ 358 197-301 20" Single Row Light Bar (Spot)

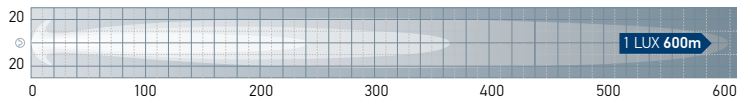

1GJ 358 197-321 40" Single Row Light Bar (Spot)

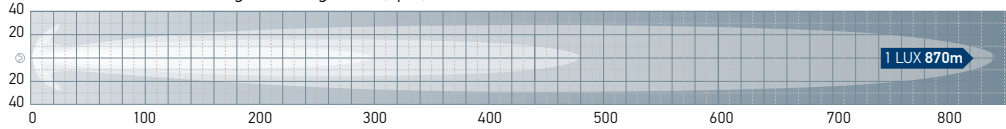

1GJ 358 197-401 21.5" Double Row Light Bar (Combi)

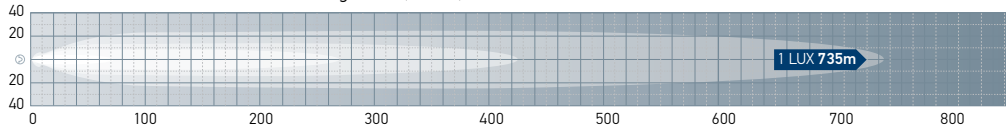

1GJ 358 197-411 30" Double Row Light Bar (Combi)

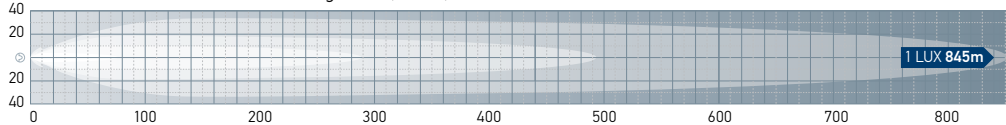

BLACK MAGIC TOUGH



ROAD LEGAL LIGHT BARS

Take your adventure from the Bush to the Highway, with road legal Black Magic Mini Light Bars.

Fully ECE R112 compliant, these 7" and 13" Light bars can be wired directly into your vehicle's high beam circuit, when mounted in pairs.

Experience the freedom with these on and off-road, Go Anywhere Mini Light bars.



7" Mini Double Row Light Bar*

1FJ 358 196-451 (Spot)



13" Mini Double Row Light Bar*

1GJ 358 196-461 (Spot) ★



★ **SPECIAL ORDER ITEM**

For delivery timeline contact your local HELLA distributor.

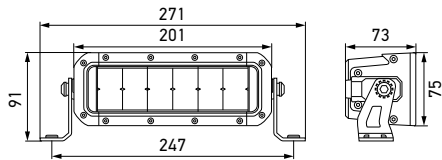

1FJ 358 196-451 7" Mini Double Row Light Bar (Spot)

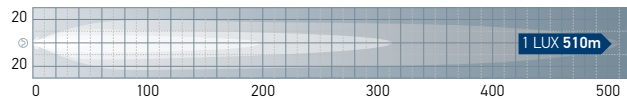

1FJ 358 196-451 7" Mini Double Row Light Bar (Spot)

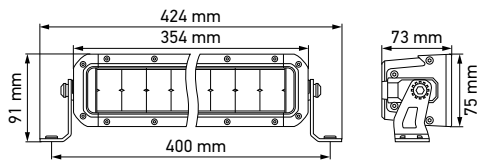

1GJ 358 196-461 13" Mini Double Row Light Bar (Spot)

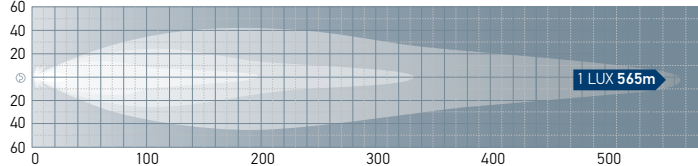

1GJ 358 196-461 13" Mini Double Row Light Bar (Spot)

All dimensions in mm

All Mini Double Row Light Bar lux maps show output for a pair

Model	7" Mini Double Row Light Bar	13" Mini Double Row Light Bar
Part Number	1FJ 358 196-451	1GJ 358 196-461
Beam	Spot	Spot
Max Light Output (lumen)	2100	3800
Beam Distance (Metres)	510m @ 1Lux (pair)	560m @ 1Lux (pair)
Beam Width (Metres)	42m @ 1Lux (pair)	84m @ 1Lux (pair)
Max Power Consumption	28W	55W
Weight	1700g	2150g
ECE	ECE10 / *ECE R112 compliant, allowing for direct connection into vehicle high beam circuit when mounted in pairs	
Mounting	Upright/pendant	
Voltage	10-30V DC (suitable for 12 or 24V DC applications)	
Colour temperature	5700K	
Cable length	2m cable with open ends	
Protection	Reverse polarity protection. IP68 (Protection against dust and water immersion). IP69K (Protection against dust and high-pressure/steam jet cleaning)	
Housing	Aluminium, black stainless steel bracket	
Compliance		

BLACK MAGIC TOUGH CURVED



Curved models follow the arc of your windshield, for an even wider spread of light. Combined with the formidable TOUGH range construction and performance, there's nothing better to traverse the darkness.

30" Double Row Curved Light Bar

1GJ 358 197-611 (Wide Combi) ★



40" Double Row Curved Light Bar

1GJ 358 197-621 (Spot) ★



52" Double Row Curved Light Bar

1GJ 358 197-641 (Wide Combi) ★



★ SPECIAL ORDER ITEMS

For delivery timeline contact your local HELLA distributor.

Model	30" Double Row Curved Light bar	40" Double Row Curved Light bar	52" Double Row Curved Light bar
Part Number	1GJ 358 197-611	1GJ 358 197-621	1GJ 358 197-641
Beam	Wide Combi	Spot	Wide Combi
Max Light Output (lumen)	13500	16000	20000
Beam Distance (Metres)	540m @ 1Lux	510m @ 1Lux	590m @ 1Lux
Beam Width (Metres)	96m @ 1Lux	104m @ 1Lux	112m @ 1Lux
Max Power Consumption	310W	426W	500W
Weight	4500g	5500g	6700g
ECE R10	Recommended for Motorsport or off-road use only. Must be switched independently of headlamps		
Mounting	Upright/pendant		
Voltage	10-30V DC (suitable for 12 or 24V DC applications)		
Colour temperature	5700K		
Cable length	2m cable with open ends		
Protection	Reverse polarity protection. IP68 (Protection against dust and water immersion). IP69K (Protection against dust and high-pressure/steam jet cleaning)		
Housing	Aluminium, black stainless steel bracket		
Compliance	CE		

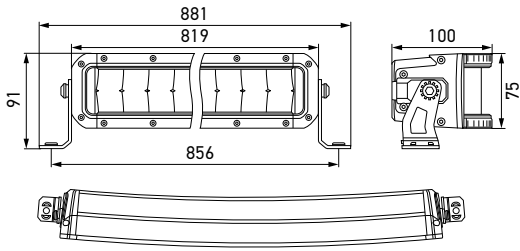

16J 358 197-611 30" Double Row Curved Light Bar

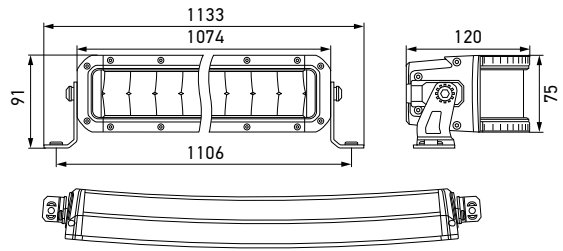

16J 358 197-621 40" Double Row Curved Light Bar

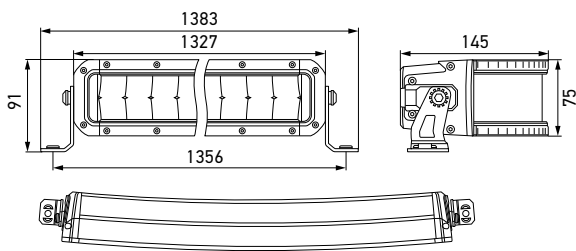

16J 358 197-641 52" Double Row Curved Light Bar

All dimensions in mm

16J 358 197-611 30" Double Row Curved Light Bar (Combi)

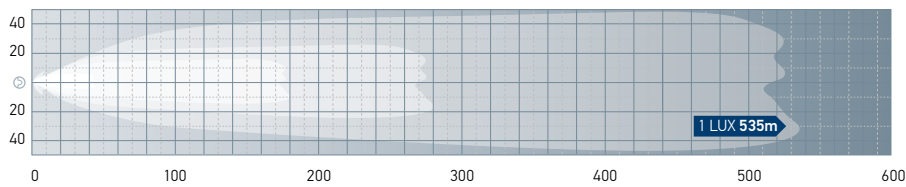

16J 358 197-621 40" Double Row Curved Light Bar (Spot)

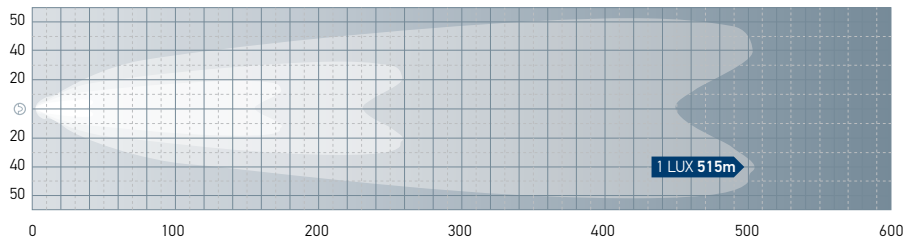

16J 358 197-641 52" Double Row Curved Light Bar (Combi)

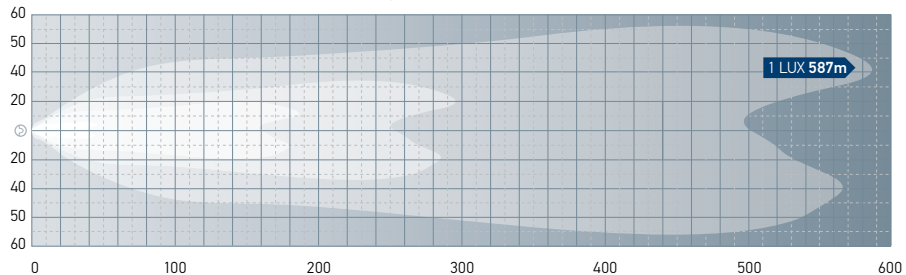

BLACK MAGIC ORIGINAL



The original Black Magic Light Bars, with their attractive all-black appearance and compact, edgeless design. These light bars deliver up to 12000 lumen, making them ideal for any off-road adventure.



6.2" Mini Light Bar
1FB 358 176-201 (Flood)



6.2" Mini Light Bar
1FB 358 176-211 (Spot)

21.5" Double Light Bar
1FJ 358 176-401 (Spot)



20" Single Light Bar
1FJ 358 176-301 (Spot)



40" Single Light Bar
1FJ 358 176-321 (Spot)

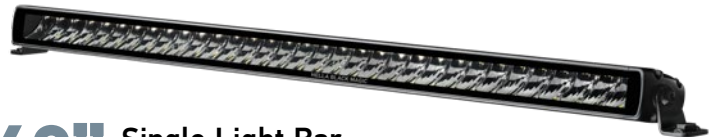

Model	6.2" Mini Light Bar	6.2" Mini Light Bar	21.5" Double Light Bar	20" Single Light Bar	40" Single Light Bar
Part Number	1FB 358 176-201	1FB 358 176-211	1FJ 358 176-401	1FJ 358 176-301	1FJ 358 176-321
Beam	Flood	Spot	Spot	Spot	Spot
Max Light Output (lumen)	1600	1600	11000	6000	12000
Beam Distance (Metres)	79m @ 1Lux	424m @ 1Lux	430m @ 1Lux	560m @ 1Lux	595m @ 1Lux
Beam Width (Metres)	34m @ 1Lux	36m @ 1Lux	120m @ 1Lux	84m @ 1Lux	84m @ 1Lux
Max Power Consumption	30W	30W	200W	105W	210W
Weight	470g	470g	2420g	1400g	2400g
ECE R10	Recommended for Motorsport or off-road use only. Must be switched independently of headlamps.				
Mounting	Upright/pendant				
Voltage	Multi-voltage suitable for 12 or 24V DC applications				
Colour temperature	5700K				
Cable length	800mm cable with open ends		2m cable with open ends		
Protection	Reverse polarity protection. IP68 (Protection against dust and water immersion). IP69K (Protection against dust and high-pressure/steam jet cleaning)				
Housing	Aluminium, black stainless steel bracket				
Compliance	CE				

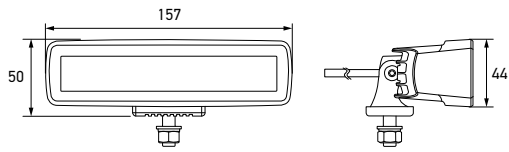

1FB 358 176-201, 1FB 358 176-211 6.2" Mini Light Bar

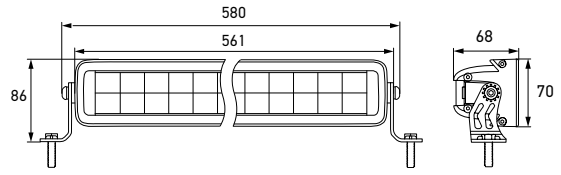

1FJ 358 176-401 21.5" Double Light Bar

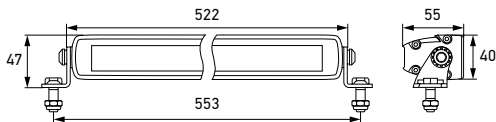

1FJ 358 176-301 20" Single Light Bar

All dimensions in mm

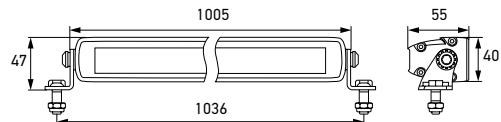

1FJ 358 176-321 40" Single Light Bar

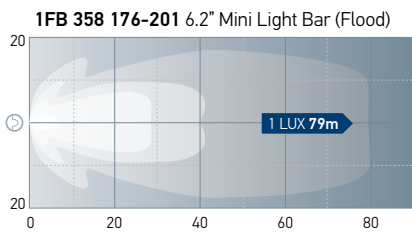

Not shown to scale

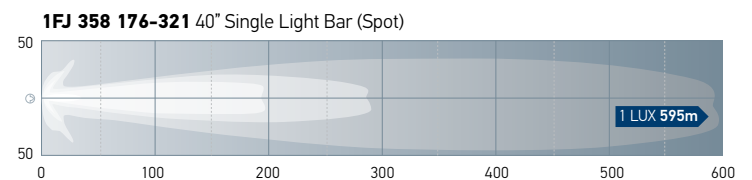
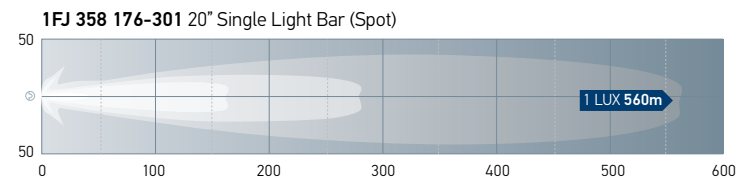
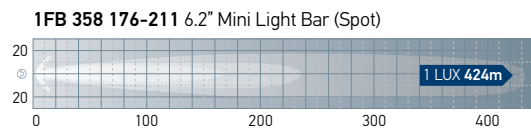
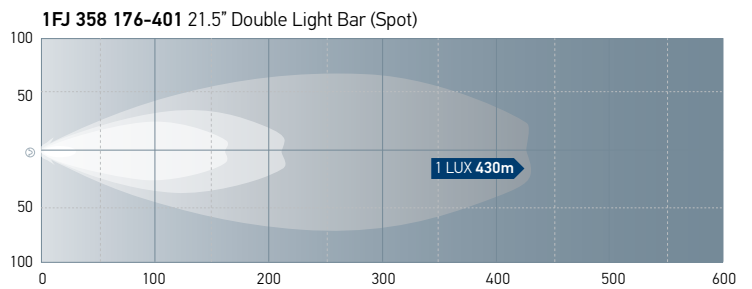

BLACK MAGIC CUBES



COMPACT YET POWERFUL

Don't let their small size fool you; these lights pack a punch!

Black Magic Cubes' tiny size offers huge mounting flexibility on any vehicle, while delivering up to a mighty 6000 lumen per pair. Their compact design allows them to be fitted where other lights cannot, without sacrificing performance.

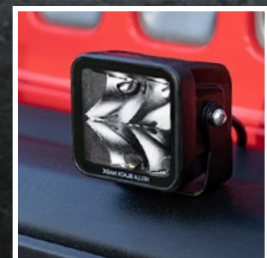

**ECE
R10****IP68
IP69K****12/24V
MULTIVOLT****UV
RESISTANT****2YR
WARRANTY****2.7"****Cube Driving Light**

1FA 358 176-841 (Flood)

3.2"**Cube Driving Light**

1FA 358 176-851 (Flood)

1FA 358 176-861 (Spot)

3.2"**Cube Driving Light Kit**

1FA 358 176-821 Kit (Spot)

Includes 2x Lamps & wiring harness

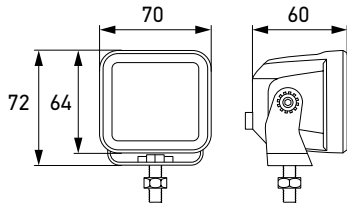
**1FA 358 176-841** 2.7" Cube Driving Light

All dimensions in mm

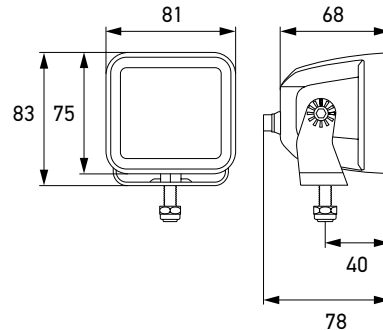
**1FA 358 176-851****1FA 358 176-861** 3.2" Cube Driving Light**1FA 358 176-821** 3.2" Cube Driving Light Kit**1FA 358 176-841**

2.7" Cube Driving Light (Flood)

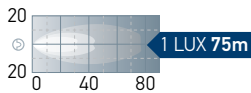
**1FA 358 176-851**

3.2" Cube Driving Light (Flood)

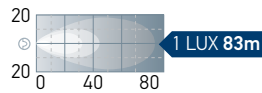
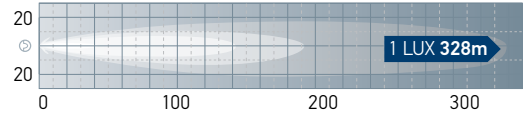
**1FA 358 176-861** 3.2" Cube Driving Light (Spot)**1FA 358 176-821** 3.2" Cube Driving Light Kit (Spot)

All Cube lux maps show output for a pair.

Model	2.7" Cube Driving Light	3.2" Cube Driving Light	3.2" Cube Driving Light	3.2" Cube Driving Light Kit
Part Number	1FA 358 176-841	1FA 358 176-851	1FA 358 176-861	1FA 358 176-821
Beam	Flood	Flood	Spot	Spot
Max Light Output (lumen)	1400	3000	3000	6000 (pair)
Beam Distance (Metres)	75m @ 1Lux (pair)	83m @ 1Lux (pair)	328m @ 1Lux (pair)	328m @ 1Lux (pair)
Beam Width (Metres)	28m @ 1Lux (pair)	36m @ 1Lux (pair)	36m @ 1Lux (pair)	36m @ 1Lux (pair)
Max Power Consumption	20W	40W	40W	80W (pair)
Weight	350g	358g	358g	358g
ECE R10	Recommended for Motorsport or off-road use only. Must be switched independently of headlamps.			
Mounting	Upright/pendant			
Voltage	Multi-voltage suitable for 12 or 24V DC applications			
Colour temperature	5700K			
Cable length	500mm cable with integrated DT Socket			
Protection	Reverse polarity protection. IP68 (Protection against dust and water immersion). IP69K (Protection against dust and high-pressure/steam jet cleaning)			
Housing	Aluminium, black stainless steel bracket			
Compliance	CE			



APPLICATION GUIDE

RANGE	LIGHT OUTPUT	APPLICATION
Black Magic TOUGH Single Row Light Bar	Pencil beam (Fully Focused) All light focused to give maximum distance with no short range	Great for rural areas, long highways and higher speeds where you need to spot objects at a distance. Good combined with great shorter distance lamps
Black Magic TOUGH Double Row Light Bar	Combination beam (Pencil + Flood Driving) With lumens to spare, this range give a similar distance to the TOUGH Single, plus plenty of light spread for short to medium range flood	When light output really matters, this combination of Pencil (distance) and Flood beams gives you the most confidence on or off-road. 4x4 touring, Off-road, heavy commercial, and long haul driving applications
Black Magic TOUGH Mini Double Row Light Bar R112 (Road Legal)	Spot beam (Semi-Focused) Middle to Long range light with no short range	The TOUGH Mini Light Bars are set apart by their ECE R112 certification, allowing these lamps to be legally switched with the high beam circuit, when mounted as a pair
Black Magic TOUGH Double Row Curved Light Bar	Wide Combination beam (Spread + Flood Driving) Same as TOUGH Double Straight, but emphasis on giving light penetration at distance off to the sides. Foregoing some distance	Like the TOUGH Straight, this combination beam with wider output helps you see the next turn sooner and safer. Better follows the roof line of the vehicle, giving a more even roof line gap, and a unique aesthetic
Black Magic Original Single Row Light Bar Black Magic Cube Driving Light (Spot)	Spot beam (Semi-Focused) Middle to Long range light with no short range	With the sleek look and mid range light output, this is a great option for better distance visibility in extra urban areas and long straights
Black Magic Original Double Row Light Bar Black Magic Cube Driving Light (Flood)	Wide beam (Flood) Lots of light intensity in the Short to Mid range	With the sleek look and mid/short range light output, this is a great option for better overall visibility in narrow bush tracks or winding roads

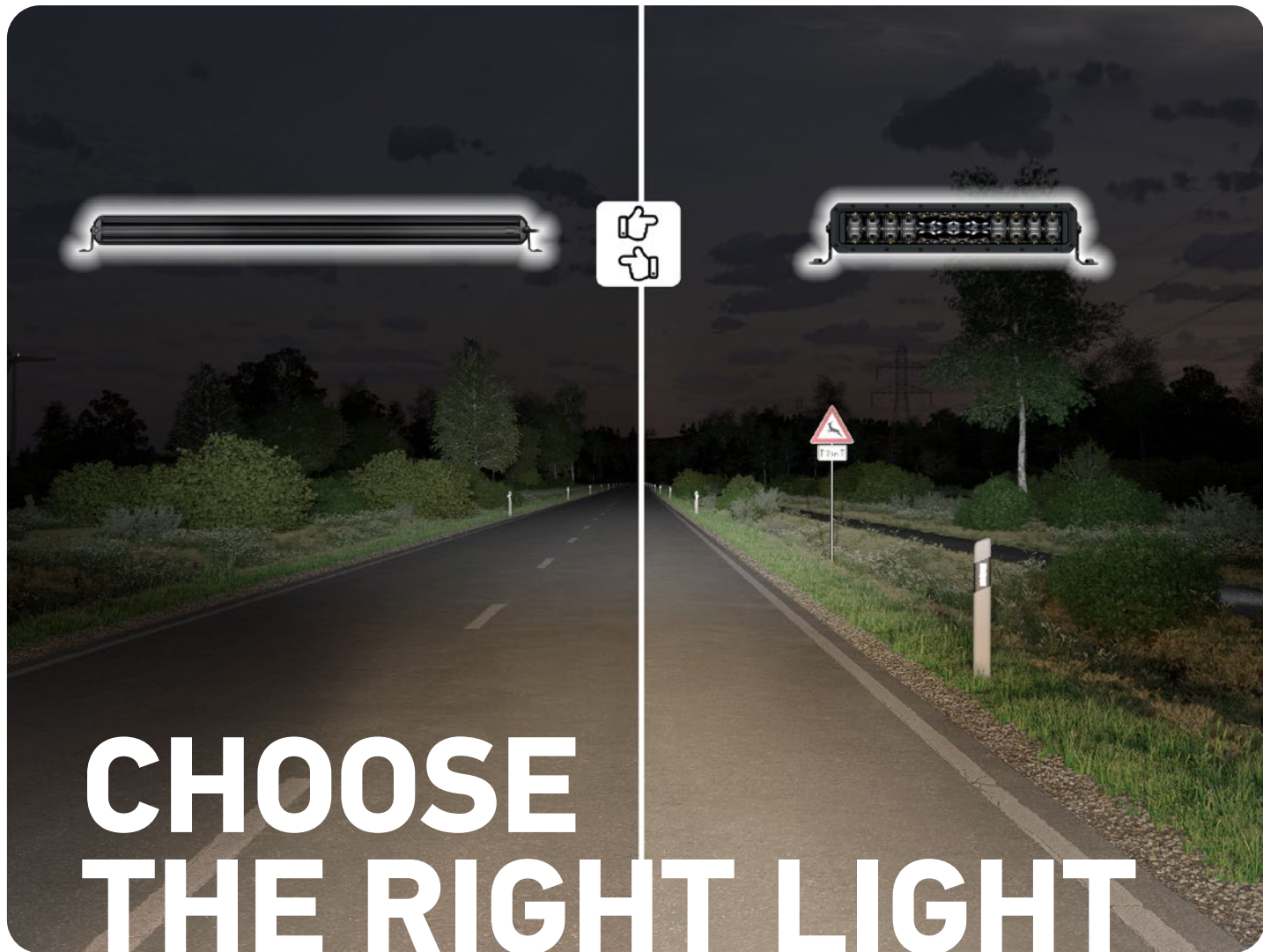

HELLA ELIVER Light Bar Guide

Compare Black Magic Light Bars to help choose the right HELLA performance lighting solution for your next adventure.

See side-by-side comparisons of HELLA light ranges, with actual driver's perspective, and top-down views for each light.

Choose the right light, and conquer the darkness.

<https://www.hella.com/MicroSite/eliver/>



HELLA-New Zealand Limited.
81-83 Ben Lomond Crescent
Pakuranga, 2010
Auckland
New Zealand

Sales/Customer Service:
Tel: +64 9 577 0366

www.hella.co.nz



BLACK MAGIC **DRIVING LIGHTS**

Start your Adventure with the Black Magic range
of Rugged Light Bars and Driving Lights, for On and Off-Road use.

