

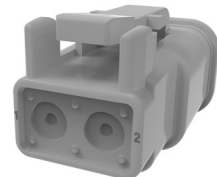

Deutsch DT series connectors are designed to withstand extreme environmental and industrial conditions due to their silicone seals and thermoplastic housings. DT connectors are ideal for use in automotive and industrial applications that require a connection of the highest quality, providing reliability and performance at a low cost. DT series connectors are available individually or in a kit form which consist of a plug, receptacle and wedges to suit your choice of solid contacts or stamped and formed contacts.

Deutsch DT Connectors to suit LED Lamp Distribution Box



2 Pole Plug (DT06-2S)



Pin numbers

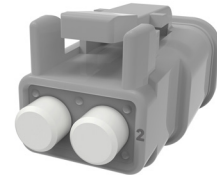

2 Sealing Plugs (114017)

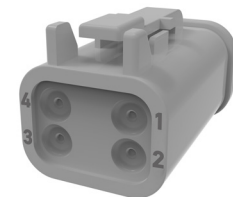

4 Pole Plug (DT06-4S)



Pin numbers

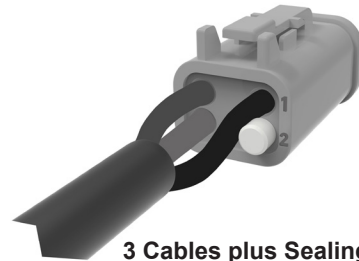

3 Cables plus Sealing Plug

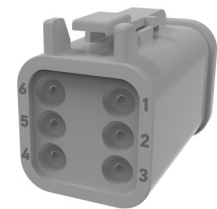

6 Pole Plug (DT06-6S)

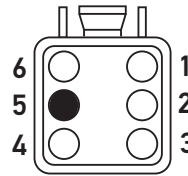

Pin numbers

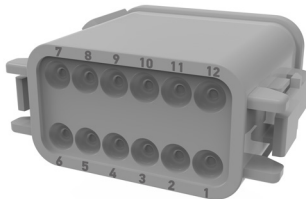

12 Pole Plug (DT06-12SA)

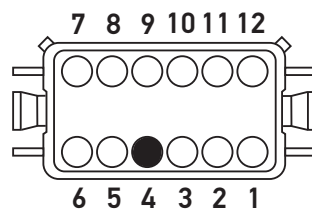

Pin numbers

NOTE : Pin numbers shown as viewed from rear of plug. Ground Pins (for use with LED Distribution Box) are shaded black.

PLUG KITS (not included)

Standard DT Kit Contents for P/N 8KW 959 774-851

- DT06-12SA x1
- W12S x1
- DT06-6S x3
- W6S x3
- DT06-4S x4
- W4S x4
- DT06-2S x6
- W2S x6
- 0462-209-16141 x12 (large terminal for 12 pole DT input)
- 0462-201-16141 x46 (small terminal for all outputs)
- 114017 x29 (seal plugs)

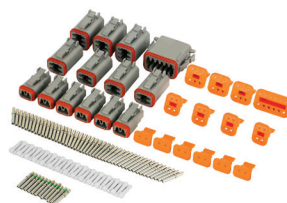

Heat Shrink Compatible Kit Contents for P/N 8KW 959 774-861

- DT06-12SA-E008 x1
- W12S x1
- DT06-6S-E008 x3
- W6S x3
- DT06-4S-E008 x4
- W4S x4
- DT06-2S-E008 x6
- W2S x6
- 0462-209-16141 x12 (large terminal for 12 pole DT input)
- 0462-201-16141 x46 (small terminal all outputs)
- 114017 x29 (seal plugs)

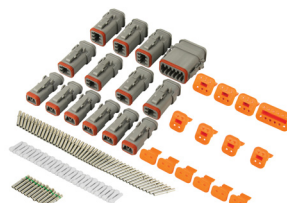

LED LAMP DISTRIBUTION BOX
Suitable for 12 and 24 volt systems



Introduction

Connecting LED lighting to your truck, trailer or vessel has never been easier or more reliable. HELLA's revolutionary LED Lamp Distribution Box makes installing LED lamps quicker and easier. Simple plug in connectivity isolates circuits to protect lamps and facilitates fast fault finding if required, meaning quicker installation and less downtime during service or repair.

Utilising 'state of the art' technology, innovative design and durable materials the HELLA LED Lamp Distribution Box removes the need for complicated junction boxes that are prone to faults. Connections are made easily using proven Deutsch DT plug components. The completely sealed housing protects internal electronics that isolate potential faults or lamp failures to a single circuit, making repair and maintenance quick and easy.

The LED Lamp Distribution Box is supplied with a set of 4 mounting clips for screw or bolt mounting, which can be placed in a variety of positions. If required, this box can also be secured with two cable ties (e.g. 375mm+ x 6mm).

Compatibility to existing electrical systems

It is important for the installer to ascertain the compatibility of the low power consumption LED lamps with the electrical and/or electronic systems of the complete vehicle, including trailers.

For certain functions some electrical systems rely on a set power consumption for monitoring whether, for example, a trailer is connected. In most cases the reduced power consumption from LED lamps is beneficial by imposing less demands on the entire electrical system.

Note: Not for use with Alternating Current (AC) or with pulse width modulated direct current (PWM DC). Due to the power restrictions of the box it is intended for use with LED lamps, as bulb lamps (e.g. 21W) will trigger the fuse at 12V.

Electromagnetic Compatibility (EMC)

This Distribution Box is an electronic device, however does not contain any active electronic components meaning it is RFLCommSafe™.

APPLICATION AND MOUNTING INSTRUCTIONS

Product Specifications:

- Housing Material: ASA Plastic
- Mounting: Horizontal or Vertical, Surface Mount (4x mounting clips provided)
- Plug Connections: Deutsch DT Plugs (not provided - see page 8 for details)
- Voltage: Suitable for 12V and 24V DC
- Current per output pin:

Ambient Temperature (°C)	-40	-20	0	20	25	40	50
Maximum Output (A)	2.83	2.50	2.20	1.85	1.74	1.53	1.37

NB: 1.3A is the recommended maximum to suit Multivolt operation for all vehicle voltages and operating temperatures.

- Maximum Input: 13A
- Operating Temperature: -40° to 50° Celsius
- Protection: Resettable fuse on all output pins
IP6K7 (Protection against dust and temporary water immersion)
IP6K9K (Protection against dust and high pressure/steam jet cleaning)
- Applications: Truck, trailers or marine vessels
- Manufacturing Location: New Zealand

Important Notes for Installer and Vehicle Owner



Surface Mounting Instructions:

- 1) Find a mounting location that allows easy access to the required wiring, and preferably away from heat and water spray. Ideally mount on a flat surface in horizontal or vertical orientation with wiring pointing away from the direction of travel of the vehicle.
 - 2) Use the 4 provided mounting clips and slide them onto the sides of the Distribution Box, a minimum of 3 mounts on opposing sides of the Distribution Box are required. There are 12 possible mounting positions for the mounting feet as shown in the diagram below. Ensure that the box is secured prior to operation.
 - 3) \varnothing 6mm screws or bolts are recommended to mount the Distribution Box using washers or mounting bushes (not provided).
 - 4) Wire the Distribution Box referring to the following pages and check the electrical system is functioning normally. Refer to page 6 for advice on fault finding and diagnostics.
 - 5) Unused sockets must be sealed with DT connectors (not provided) with sealing plugs (ref. image 1B). Do not use any oils, lubricants, sealants or chemicals on the DT connectors. Fit the connectors first then push in the white sealing plugs if required.
 - 6) Once the plugs/cables are connected to the mounted Distribution Box, restrain them with cable ties.
- Note:** Do not attempt to open box - no serviceable parts inside.

Mounting Diagram

1B

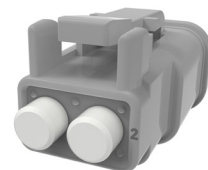

Terminate unused outputs with DT connectors and seal plugs.

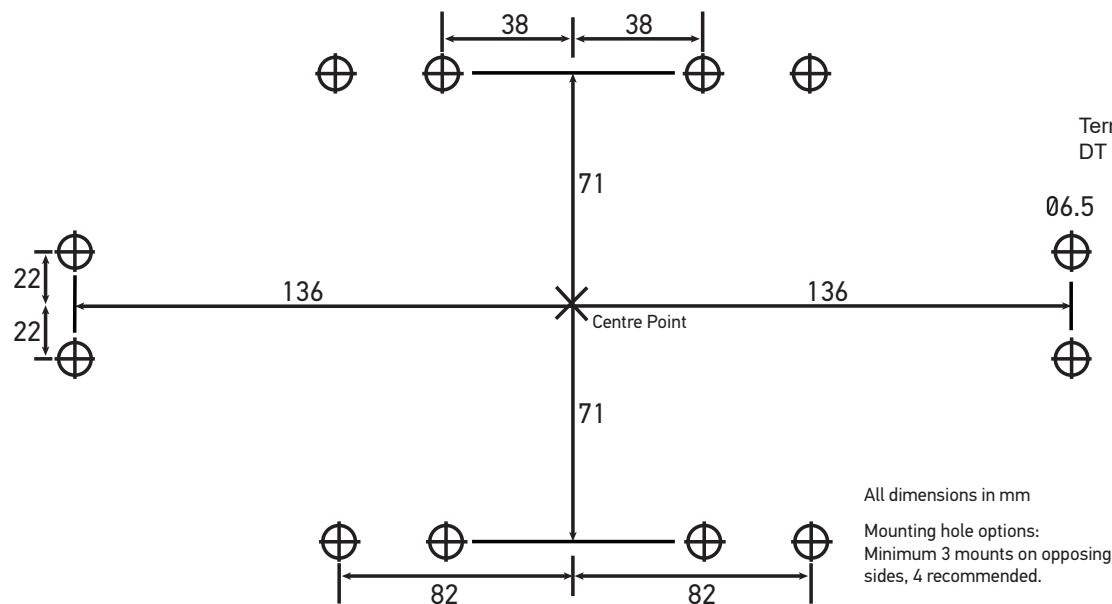

Warranty Statement

Congratulations! The product you have selected comes from Hella - one of the world's leading manufacturers of lighting products. The product comes with a 5 year warranty from end user purchase covering faults in materials, components or workmanship.

In the unlikely event that you should experience a confirmed warranty related problem with your purchase, Hella will, at its discretion, either repair, replace or refund the purchase price of the product.

Warranty services may be obtained by returning the product within the warranty period to the Hella Dealer where the product was originally purchased. This warranty is in addition to and does not preclude any other rights or remedies available to the consumer under any local legislation related to the provision of goods or services.

Our goods come with guarantees that cannot be excluded under the Australian Consumer Law. You are entitled to a replacement or refund for a major failure and for compensation for any other reasonably foreseeable loss or damage. You are also entitled to have the goods repaired or replaced if the goods fail to be of acceptable quality and the failure does not amount to a major failure.

This warranty does not cover:

- 1.) Claim/s as a result of normal wear and tear or of any modifications and / or alterations to the product in any shape or form.
- 2.) Claim/s as a result of non-compliance of the assembly, service and operating instructions and/or any unfit or improper use.
- 3.) Any expenses incurred in the process of making the claim.

Note: For lamps sold in Australia, warranty services are provided by Hella Australia Pty Ltd.,
4 Hargrave Place, Mentone, Victoria, 3194 Australia. Customer Service 1800 061 729 email: custservice@hella.com
https://www.hella.com/hella-au/assets/media_global/IAM_Statement_of_Warranty.pdf

INSTRUCTION SHEET: LED Lamp Distribution Box

for: **8JE 233 496-001**



INPUT SOCKET	Pin Number	DESCRIPTION	
CD 12Pin DT INPUT	1	(L) Left Turn Signal	
	2	(R) Right Turn Signal	
	3	Rear Fog Lamps	
	4	(31) Ground (<13A)	
	5	(58L) LH Tail, Side Marker	
	6	(58R) RH Tail, Side Marker	
	7	(54) Stop Lamps	
	8	Reverse	
	9	Permanent Voltage / Aux9	
	10	Auxiliary 10	
	11	Auxiliary 11	
	12	Auxiliary 12	
OUTPUT SOCKETS	Pin Number	DESCRIPTION	Connects to CD Input Pin Number
A LWR LH STIR (Lower Left-Hand Stop/Tail/Indicator/Reverse)	1	(58L) LH Tail, Side Marker	5
	2	(54) Stop Lamp	7
	3	(L) Left Turn Signal	1
	4	Reverse	8
	5	(31) Ground	4
	6	Auxiliary 10	10
E AUX /OUT (Reverse)	1	Reverse	8
	2	Permanent Voltage / Aux9	9
	3	Auxiliary 10	10
	4	Auxiliary 11	11
	5	(31) Ground	4
	6	Auxiliary 12	12
F LWR RH STIR (Lower Right-Hand Stop/Tail/Indicator/Reverse)	1	(58R) RH Tail, Side Marker	6
	2	(54) Stop Lamp	7
	3	(R) Right Turn Signal	2
	4	Reverse	8
	5	(31) Ground	4
	6	Auxiliary 10	10
G UPP LH STI (Upper Lower-Hand Stop/Tail/Indicator)	1	(58L) LH Tail, Side Marker	5
	2	(54) Stop Lamp	7
	3	(L) Left Turn Signal	1
	4	(31) Ground	4
H TURN SM LH (Left-Hand Tail/ Side Marker)	1	(58L) LH Tail, Side Marker	5
	2	(L) Left Turn Signal	1
	3	Auxiliary 11	11
	4	(31) Ground	4
J TURN SM RH (Right-Hand Tail/ Side Marker)	1	(58R) RH Tail, Side Marker	6
	2	(R) Right Turn Signal	2
	3	Auxiliary 11	11
	4	(31) Ground	4
K UPP RH STI (Upper Right-Hand Stop/Tail/Indicator)	1	(58R) RH Tail, Side Marker	6
	2	(54) Stop Lamp	7
	3	(R) Right Turn Signal	2
	4	(31) Ground	4
L SM LH (Left-Hand Tail/Side Marker)	1	(58L) LH Tail, Side Marker	5
	2	(31) Ground	4
M REVERSE	1	Reverse	8
	2	(31) Ground	4
N LP (License Plate)	1	(58) LH Tail, Side Marker	5
	2	(31) Ground	4
O REAR FOG	1	Rear Fog	3
	2	(31) Ground	4
P AUX12	1	Auxiliary 12	12
	2	(31) Ground	4
Q SM RH (Right-Hand Tail/Side Marker)	1	(58R) RH Tail, Side Marker	6
	2	(31) Ground	4



BASIC TRUCK/TRAILER WITH UPPER BODY LAMPS

(Suggested wiring diagram)

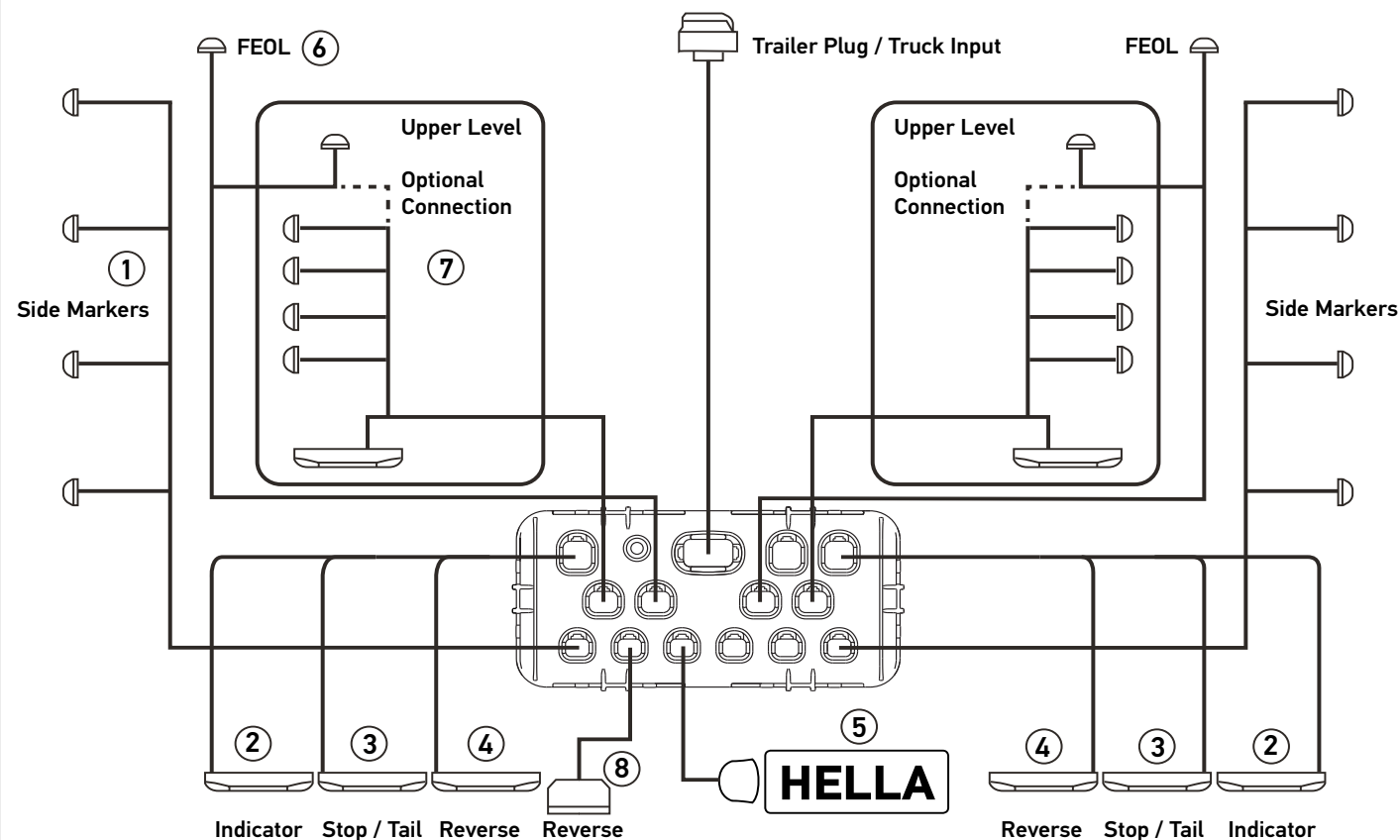

Position	Function	CD Input Pin Number	Output Socket	Max Power Consumption		Suggested usage Part Numbers
				12V	24V	
①	Side Markers	5/6	L/Q	15W	30W	30 x 2053 / 2083
②	Rear Indicator	1/2	A/F	15W	30W	2 x 2151-H / 2378
③	Stop/Tail	7/(5/6)	A/F	15W	30W	2 x 2330-H / 2378
④	Reverse	8	A/F	15W	30W	2 x 1430-H
⑤	License Plate	5	N	15W	30W	1 x 2559
⑥	Front End Outline	5/6	H/J	15W	30W	2 x 2060 / 2051
⑦	Stop/Tail/Indicator	7/(5/6)/(1/2)	G/K	15W	30W	2 x 2378 + 20 x 2053 / 2083
⑧	Reversing Work Lamp	8	M	15W	30W	1 x 1551-RE / 1547-RE
TOTAL POSSIBLE FOR SYSTEM				156W or 13A	312W or 13A	

FAULT DIAGNOSTICS

Should an electrical fault occur to any of the output circuits then the resettable fuse on that circuit only will open to protect the whole electrical system. This makes fault diagnostics easier as the issue will likely be isolated to just the circuit that failed. If multiple circuits have failed then the inputs should be checked as the issue may be related to a failure before the Distribution Box, or maybe a ground cable fault.

To diagnose the fault, determine which circuit has failed and trace it back to the relevant output socket in the LED Distribution Box. Check all wiring and equipment on that circuit to find the fault causing the issue. Once the issue has been resolved, the resettable fuse will be reset by disconnecting and reconnecting the DT plug. If the fault has been resolved successfully, the circuit should function normally.

If the circuit still does not function then check if further issues are present or determine the total current draw on the circuit with reference to the maximum output current table on page 1.



General Dimensions in mm

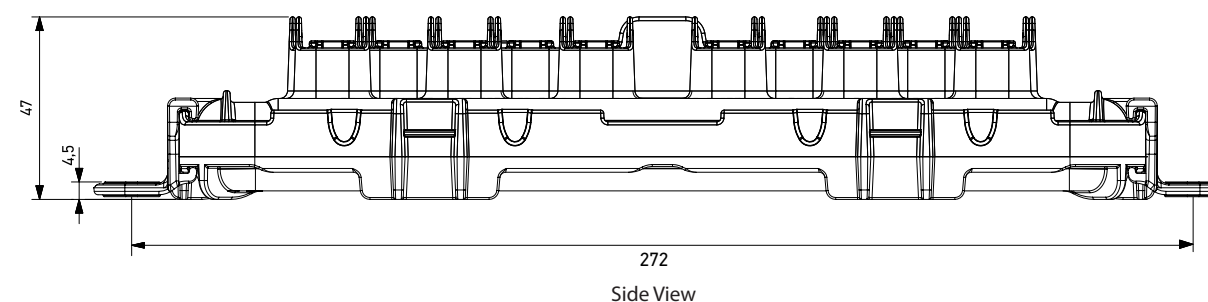
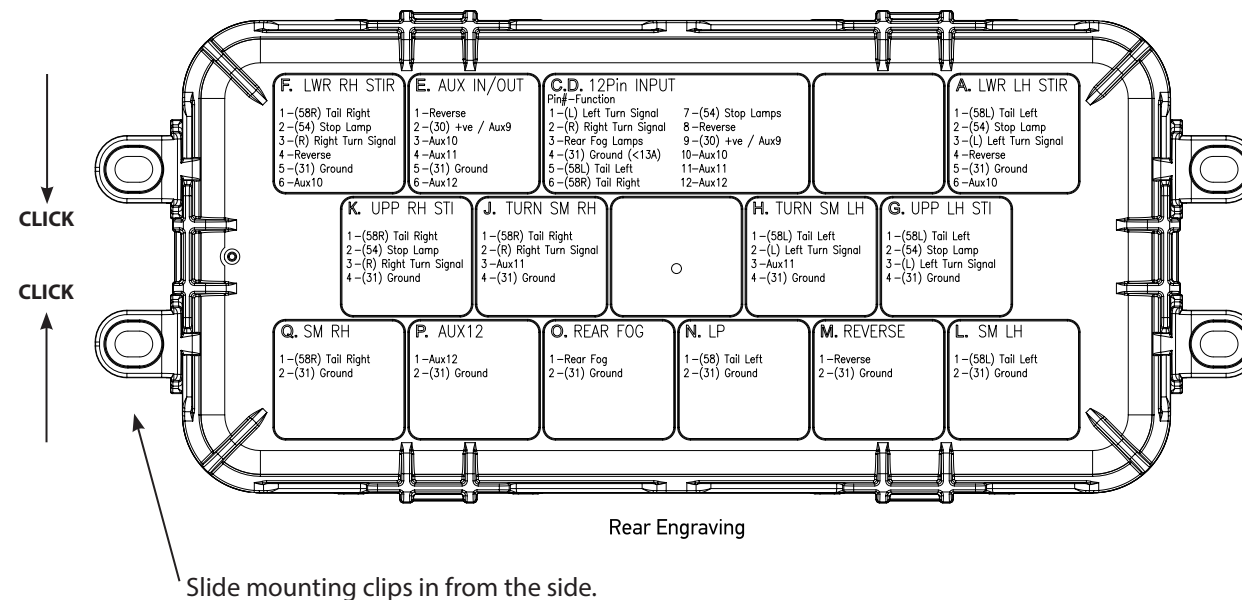
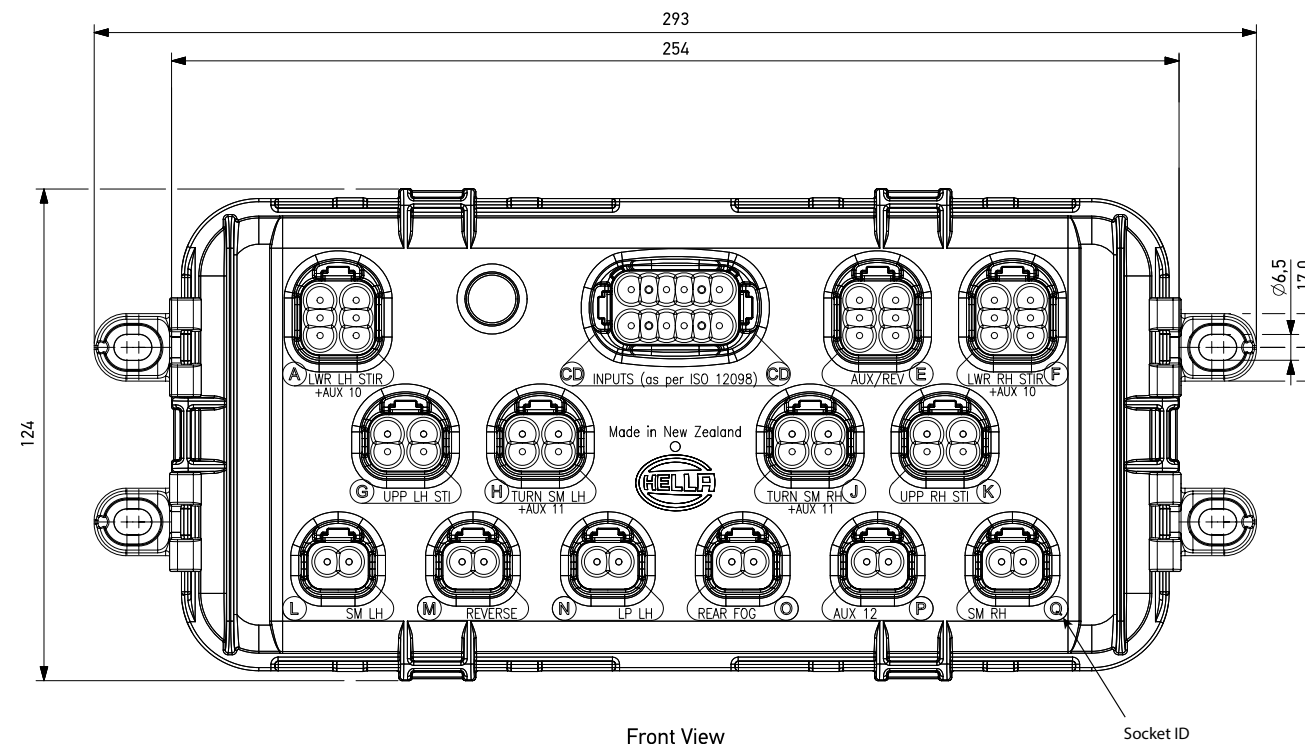

Slide mounting clips in from the side.



15 CORE CABLE WIRING

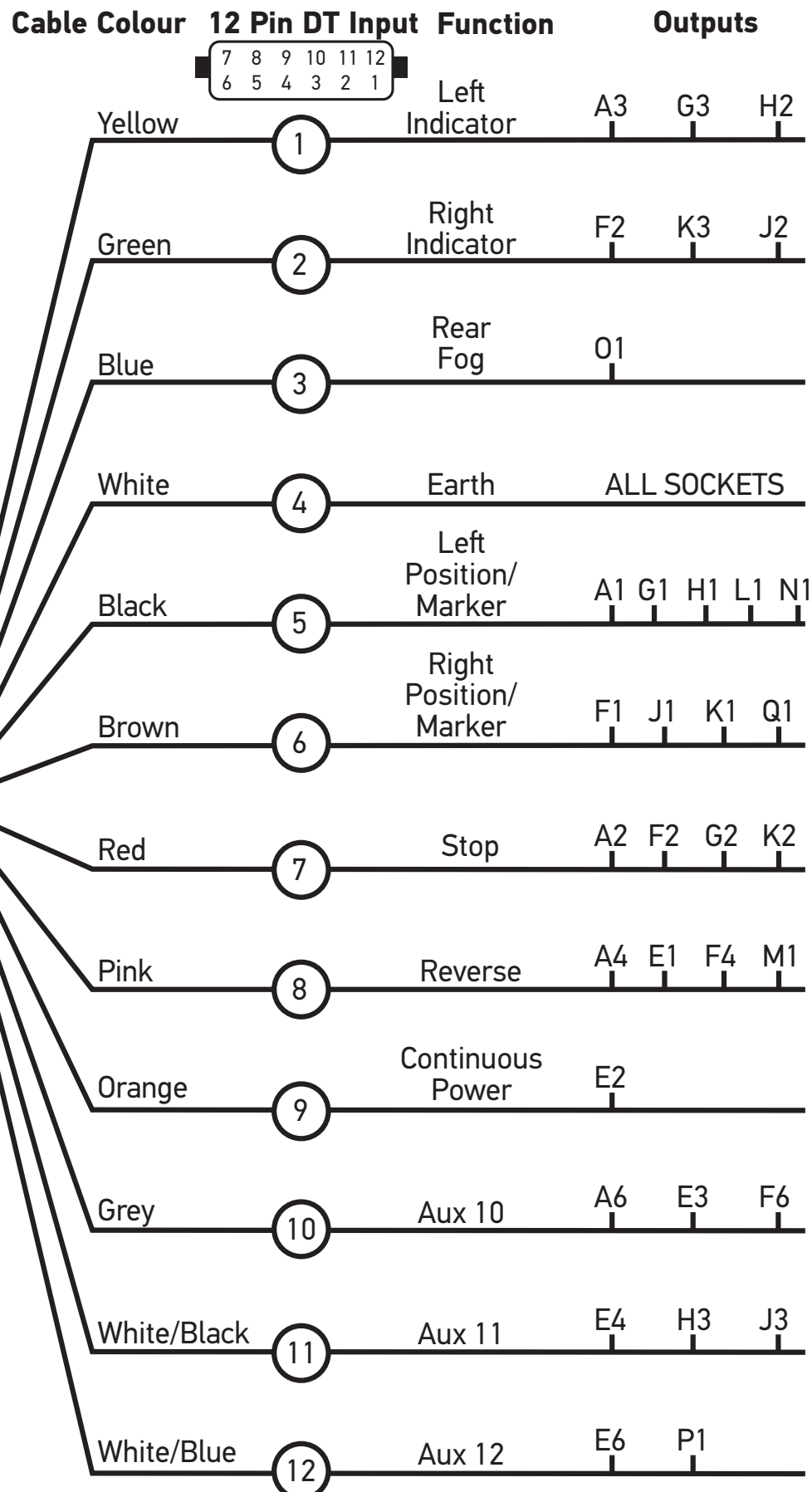

7 CORE CABLE WIRING

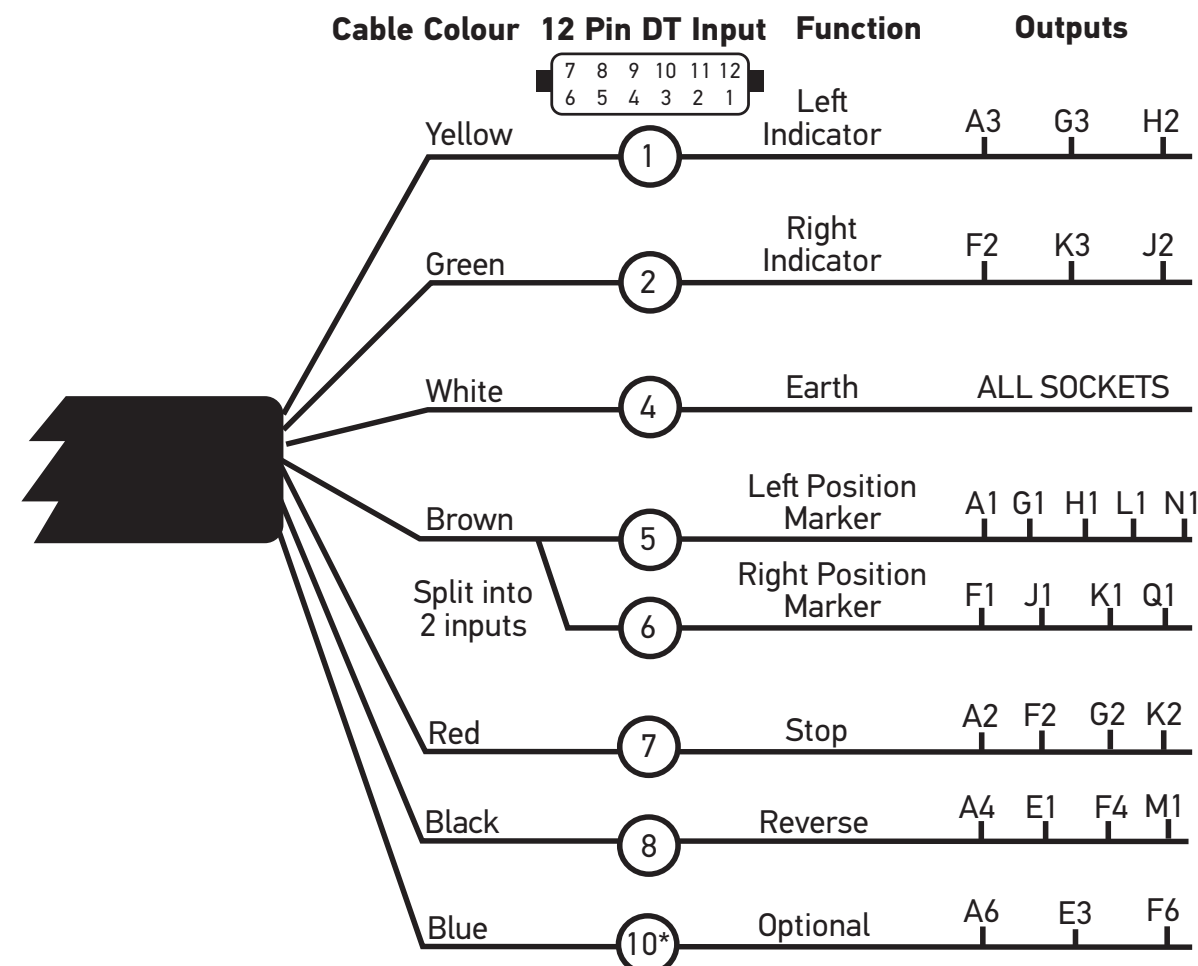

*May also use AUX 11 OR AUX 12

7 Core Cable Colour	CD Input Pin Number	Function	Output Socket / Pin Number
Yellow	1	Left Turn Signal	A3, G3, H2
Green	2	Right Turn Signal	F3, K3, J2
	3	Not used	
White	4	Ground	A5, E5, F5, G4, H4, J4, K4, L2, M2, N2, O2, P2, Q2
Brown (split in 2)	5	LH Tail / Side Marker	A1, G1, H1, L1, N1
Brown (split in 2)	6	RH Tail / Side Marker	F1, J1, K1, Q1
Red	7	Stop	A2, F2, G2, K2
Black	8	Reverse	A4, E1, F4, M1
	9	Not used	
Blue	10	Aux 10	A6, E3, F6
	11	Not used	
	12	Not used	

15 Core Cable Colour	CD Input Pin Number	Function	Output Socket / Pin Number
Yellow	1	Left Turn Signal	A3, G3, H2
Green	2	Right Turn Signal	F3, K3, J2
Blue	3	Rear Fog	O1
White	4	Ground	A5, E5, F5, G4, H4, J4, K4, L2, M2, N2, O2, P2, Q2
Black	5	LH Tail / Side Marker	A1, G1, H1, L1, N1
Brown	6	RH Tail / Side Marker	F1, J1, K1, Q1
Red	7	Stop	A2, F2, G2, K2
Pink	8	Reverse	A4, E1, F4, M1
Orange	9	Permanent Voltage / Aux 9	E2
Grey	10	Aux 10	A6, E3, F6
White/Black	11	Aux 11	E4, H3, J3
White/Blue	12	Aux 12	E6, P1
White/Red	13	Not used	
White/Green	14	Not used	
White/Brown	15	Not used	